

SS36 Assembly Instructions

Thank you for purchasing these SS36 36" Premium Speaker Stands. Please read these instructions carefully before use. Make sure all parts are included. If any parts are missing please contact our technical help line at 1-646-758-0144, 24 hours a day/7 days a week.

Scan the QR codes or go to the URLs to access how-to video(s), the owner's manual, and other important information you may need to get the most out of your item.



rockvillesupport.com/ss36b



rockvillesupport.com/ss36c









rockvillesupport.com/ss36d

Specifications

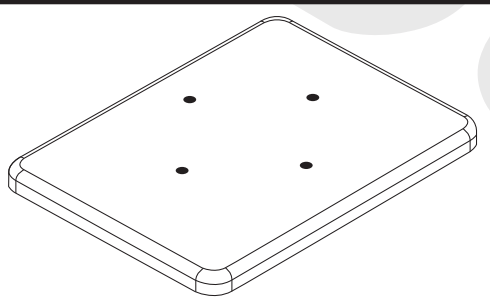
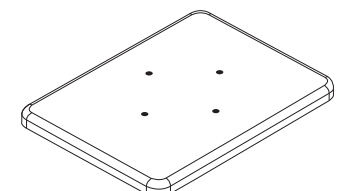
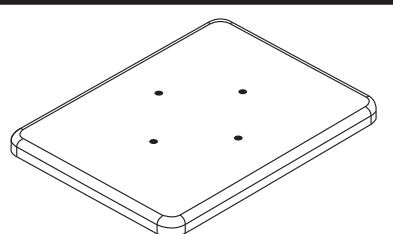
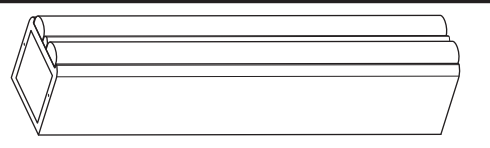
- Stand height: 36"
- Load capacity: 100 Lbs
- Large platform size: 11.8" x 9.25"
- Small platform size: 7.28" x 9.25"
- Base plate: 12.6" x 10.23"
- Stand weight: 15 Lbs (each)/30 Lbs (per pair)

Tools needed:

- Phillips-head screwdriver

base plate		2 pcs.
small top plate		2 pcs.
large top plate		2 pcs.
Stand column		2 pcs.
EVA isolation pads		8 pcs.
Phillips-head screws		16 pcs.
brass isolation spikes		8 pcs.
rubber isolation spikes		8 pcs.
cable clips		4 pcs.
cable ties		4 pcs.

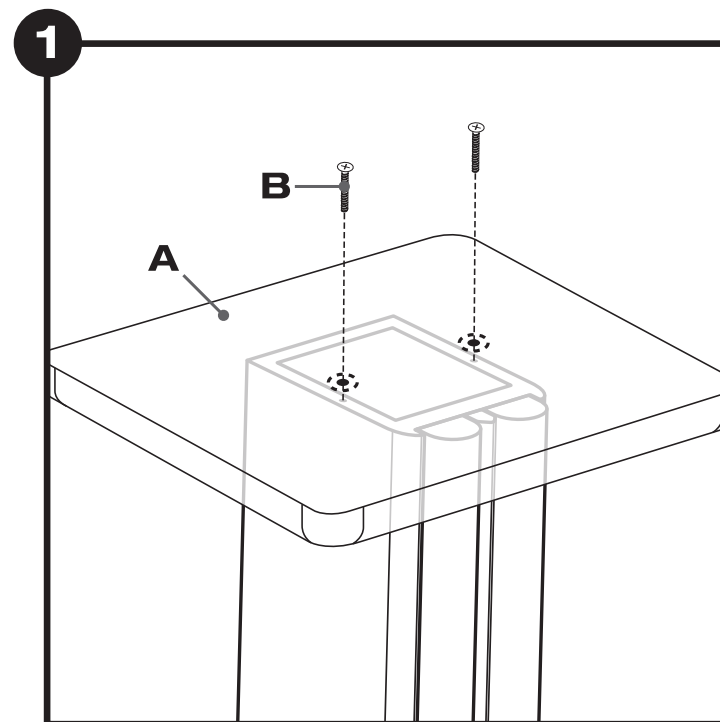

Attach the base plate (A; flat side up) by aligning the screw holes on the plate with those on the wider sides of the stand column. Use two screws (B) to secure it in place.

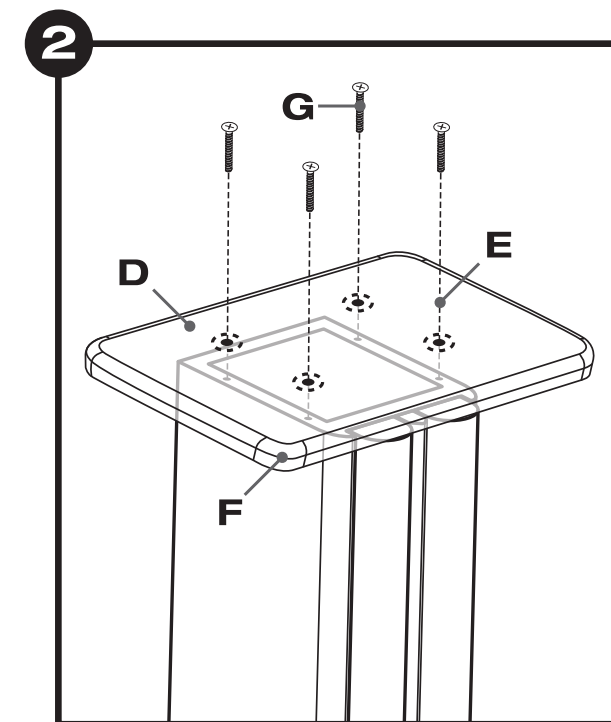

Select the appropriate size top plate (D; there are two included). Align the holes on the plate with the holes on the stand column (E). Make sure that the beveled side of the plate (F) is facing up. Use four screws (G) to secure it in place.

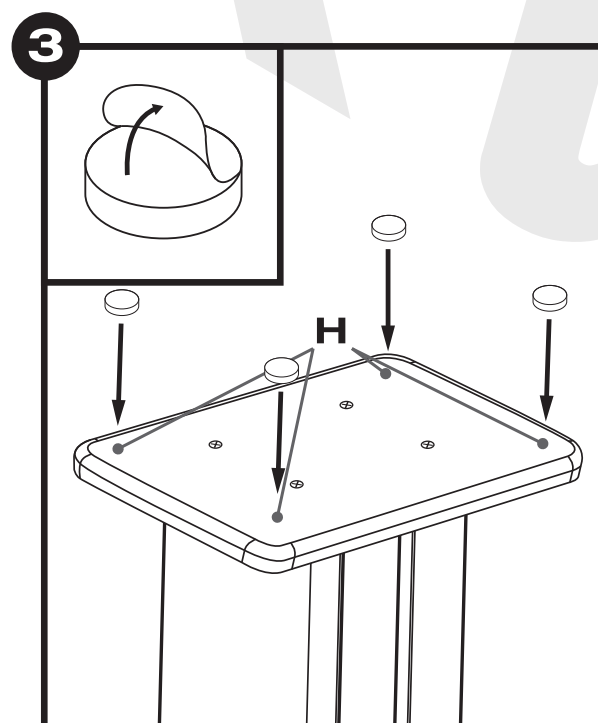

Peel back the cover on the adhesive side of the EVA sound isolation pads (see inset) and place one on each corner of the top plate (H). These pads help to minimize resonance.

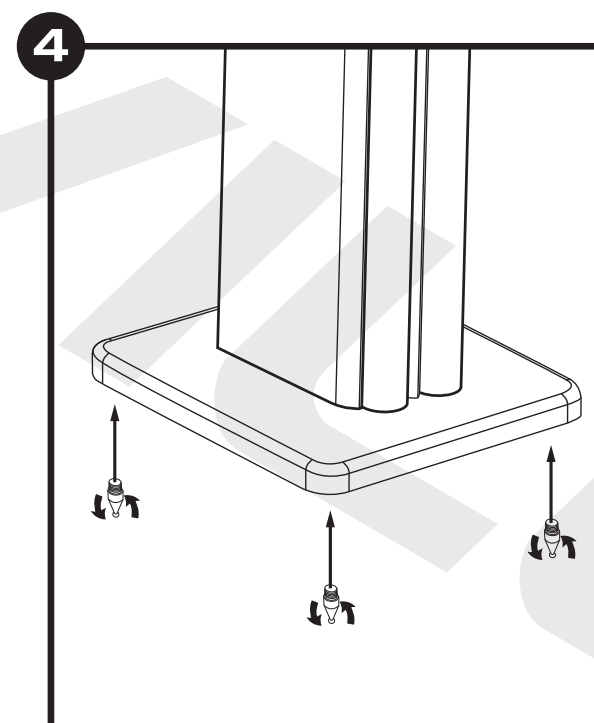

Now attach the isolation spikes to the bottom of the base plate (brass spikes shown). If needed, adjust the spike height to keep the stand level. To place the stand on a carpeted floor, use the brass spikes. If you are placing the stand on a wood, laminate, tile, or bare floor you should use the included rubber spikes.

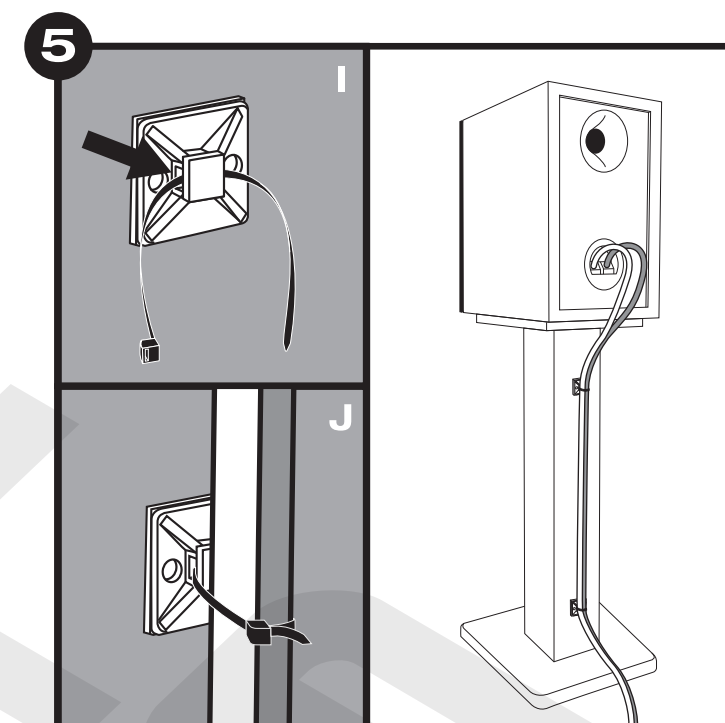

The final step is to attach the cable clips to the back of the unit. Peel the cover off of the adhesive backing and place the clips in the desired locations. Once the clips are in place, slide a zip tie through the opening on the side of the clip (see inset I). Use the zip tie to secure the speaker cables (see inset J).