

ROCKVILLE

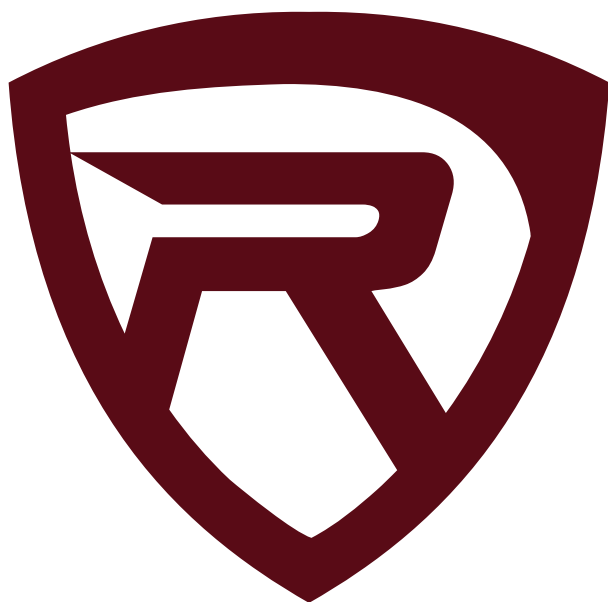

RVD12HD

12" FLIP DOWN ROOF MOUNT HIGH DEFINITION DIGITAL MONITOR WITH DVD PLAYER

OWNER'S MANUAL

Thank you for purchasing this Rockville Flip Down Roof Mounted High Resolution Digital Monitor with DVD Player and Multimedia input.

We are very proud to bring you what we consider to be the absolute best value in mobile audio products. This project has been a culmination of years of development involving a team of dreamers, engineers, designers and marketing gurus. Proudly conceived and developed in the USA, Rockville mobile audio products are designed and engineered by a team of car audio enthusiasts.

We have spared no expense in manufacturing RVD-HD series Flip Down Monitors to meet the highest quality standards. With proper care and installation this unit will provide you with the highest levels of sound quality. We hope that this unit will bring you years of performance and reliability.

Please read this installation guide carefully for proper use of your Rockville Flip Down Roof Mounted High Resolution Digital Monitor with DVD player and multi media input. Should you need technical assistance during or after your installation please call our technical help line at 1-646-758-0144, Monday through Friday, 9am to 5pm EST.

Contents

Resetting Unit	3
Powering Unit	4
User Interface	4
Control Panel	5
Remote Control Functions	6-7
DVD/USB/SD.....	8
Advanced Functions	9
Installation	10
Wiring	11
Troubleshooting	11

Precautions

- To minimize the risk of improper installation Rockville recommends that the installation of this product be performed by an MECP-Certified professional installer.
- Improper installation may cause damage to the vehicle or injury to the driver and occupants.
- Installation must be performed in accordance with this product installation manual. Rockville is not responsible for damage or injuries resulting from installation not performed strictly in accordance with the procedures described in this manual.
- Proper installation of this product may require the use of mounting hardware not included.
- Use only new, unused and properly-sized fasteners to install this product. Do not use previously installed or worn fasteners.
- No modifications to the product or mounting hardware are permitted.
- This product is designed to be used and viewed by rear seat passengers only. The monitor screen must not be visible to the driver. Viewing by the driver while operating the vehicle is not recommended.
- Rockville does not recommend connecting wires or cables to auxiliary connectors while the vehicle is in motion.
- This product must not obstruct the driver's rear view when installed or used.
- Rockville bears no liability for any property damage or personal injury that may result from improper or unintended installation or use of this product.

Resetting the Unit

- Turn the engine key to the "OFF" position
- Unplug the wire harness for five seconds. This will engage a full reset.
- Re-plug the harness.
- Turn the engine key to the "ACC" or "ON" position
- Press and hold the power button for 3 seconds
- The unit will turn on.
- If this procedure does not resolve your issue, please contact customer service for further assistance.

Powering the Unit

- Turn the engine key to the “ACC” or “ON” position
- Press and hold the power button for 3 seconds
- The unit will turn on.
- When the engine key is turned to the “OFF” position, the unit will turn off.

Tip: If the unit does not turn on, check to ensure all wires are connected properly. It is strongly suggested you seek out the help of a professional when installing.

Tip: Most functions can be accessed from the control panel, but more in-depth functions can only be performed with the remote.

User Interface

Unit Settings

- Adjust the unit settings for optimal playback.
- Selected items are highlighted by blue box.

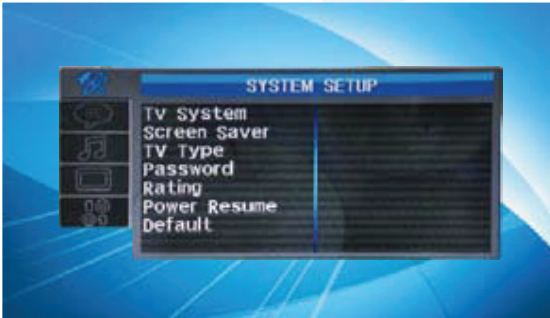

Switch Media Devices

- Press the “USB/SD” button to switch between Disc, SD, and USB devices.

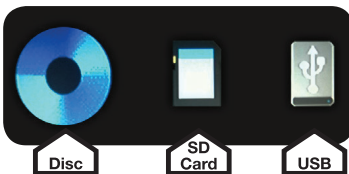

Tip: Refer to DVD and USB/SD sections for a list of playable media formats.

Media Files

- Browse the files stored in connected SD or USB device.

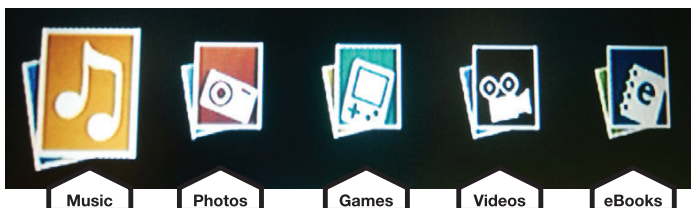

Control Panel

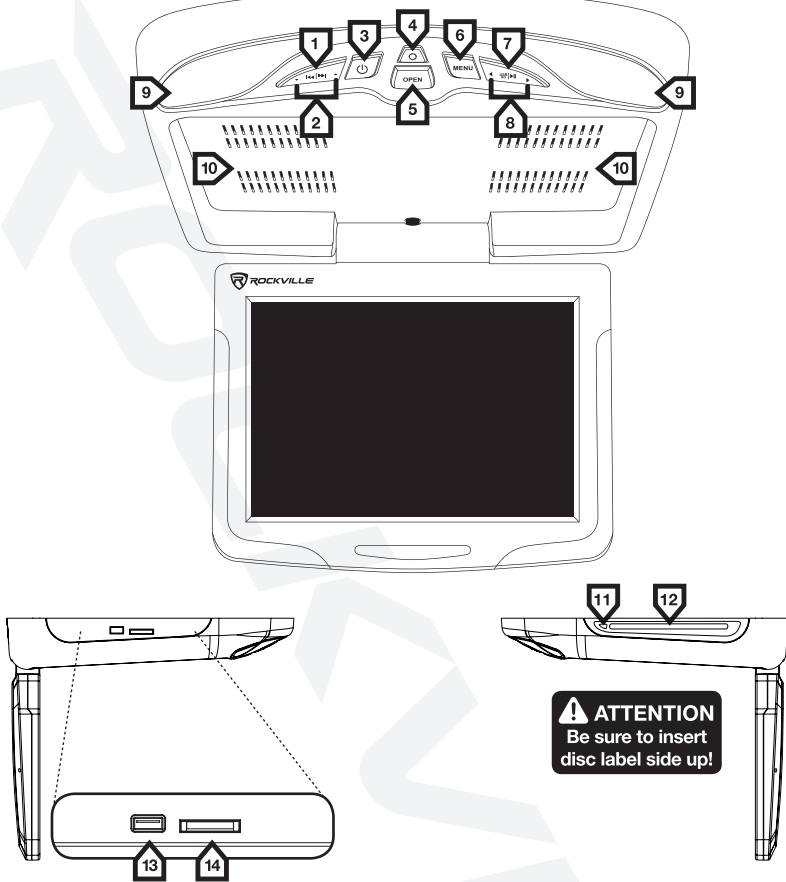

1	Previous/Rewind Next/Fast Forward	Skip to previous chapter, song, picture, page, or video. Skip to next chapter, song, picture, page, or video.
2	Up/Down	Navigate up or down through menu items.
3	Power ON/OFF	Press to turn-on the unit.
4	Overhead Light ON/OFF	Press to turn-on LED lights (item 9).
5	Monitor Release Button	Press to release the screen.
6	Menu	Access and adjust unit settings. When in settings menu, press to return to main menu.
7	Play/Pause	Press once to Play media. Press again to pause.
8	Left/Right	Navigate left or right through menu items.
9	Overhead Light	Super bright overhead lights.
10	Speakers	Built-In high quality speakers.
11	Eject Button	Eject DVD or CD.
12	Disc Drive	Insert DVD or CD to access media content.
13	USB Input	Connect MP3 player or thumb drive.
14	SD Input	Playback audio or video files from SD card.

Remote Control Functions

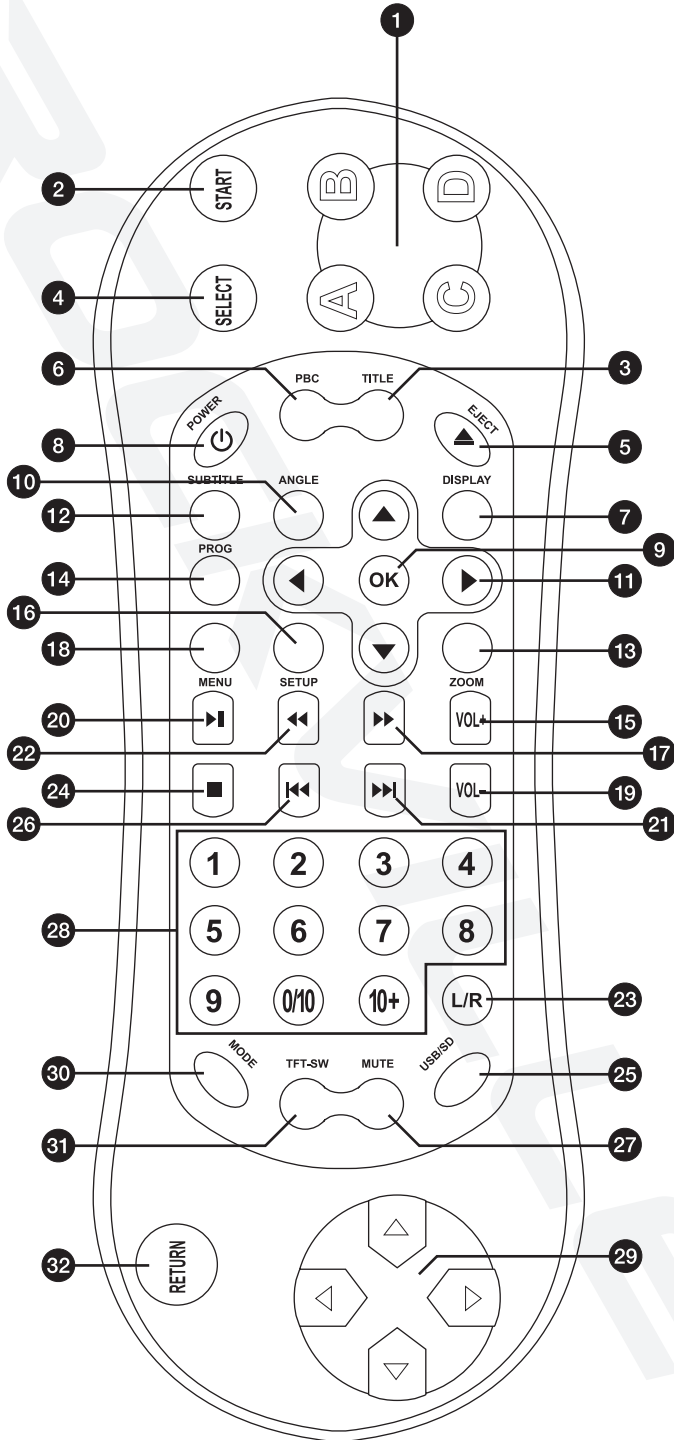

Remote Control Functions

1	Game	Use letter keys to operate game functions.
2	Start	Start game.
3	Title	Displays DVD title.
4	Select	Select game menu items.
5	Eject	Press to eject disc.
6	PBC Menu	Show playback controls.
7	Display	Displays disc information.
8	Power	Turn unit on and off.
9	Enter	Press to confirm settings.
10	Angle	Switch picture angle.
11	Cursors	Move cursor up, down, left, and right.
12	Subtitle	Switch subtitle languages.
13	Zoom	Zoom in or zoom out of picture on screen.
14	Program	Use this button to program unit.
15	Volume +	Press to increase volume.
16	Setup	Press to enter and exit setup menu.
17	FWD	Scan forward through pictures or audio.
18	TFT Menu	Press button to display the LCD menu screen.
19	Volume -	Press to decrease volume.
20	Play/Pause	Press once to play and pause content.
21	Next	Skip to next chapter, song, picture, page, or video.
22	RWD	Scan backwards through pictures or audio.
23	L/R	Toggle between left and right audio channels..
24	Stop	Press once to stop content.
25	USB/SD	Press to switch between USB and SD mode.
26	Previous	Skip to previous chapter, song, picture, page, or video.
27	Mute	Press to mute volume.
28	Number Pad	Use to input numbers.
29	Direction Pad	Use to control game and navigate game menus.
30	Mode	Switch between DVD/AV mode.
31	TFT-SW	Repeat
32	Return	Return to previous menu.

DVD

Getting Started

- Insert the DVD, **label side up**, into the disc drive.
- Wait for the DVD to load.
- Navigate the DVD menu for options.

Control

- Play/pause and navigate through the DVD menu options using the designated buttons found on both the control panel and the remote.

Playable Discs

- DVD, DVD-R, DVD-RW, DVD+RW, DVD-9, CD, CD-R, CD-RW, VCD, MP3, MP4

USB/SD

Unit Settings

- Insert USB device or SD card into the designated slots (see pages 5 for slot locations).
- Wait for the unit to load content.
- Browse files using the designated commands on the unit remote.

Playable Media Formats

- **AUDIO:** MP3, MP4, WMA
- **VIDEO:** MPEG4, AVI, WMV, VOB, Divx, MPG
- **PHOTOS:** JPG
- **BOOKS:** TXT

Tip: Video from a USB/SD is controlled the same way as DVD.

Player Password: 0000

Advanced Functions

Picture Control via Unit

- Press the MENU button on the unit to bring up the on-screen picture control menu.
- Select the desired sub-menu (COLOR, OSD, FUNCTION, and SOUND) by pressing the MENU button again.
- Press Previous/Next buttons to enter and adjust sub-menus.
- Press the MENU button to return to the previous menu.

Advanced Functions

Picture Control via Remote Control

- Press the MENU button on the remote to bring up the on-screen picture control menu.
- Select the desired sub-menu (COLOR, OSD, FUNCTION, and SOUND) by pressing the ▲ / ▼ buttons.
- Press ◀ / ▶ buttons to enter and adjust sub-menus.
- Press OK to confirm selection.
- Press the MENU button to return to the previous menu.

FM Transmitter Setup via Unit

- Press MENU button.
- Press ▲ / ▼ buttons to scroll to SOUND CONTROL menu.
- Press MENU button to make selection.
- Press ▲ / ▼ buttons to scroll to the FM menu.
- Press MENU button to make selection.
- Press ▲ / ▼ buttons to select the FM frequency.
- Press MENU button to make selection.
- Press ▲ / ▼ buttons to scroll to FM frequency menu.
- Use MENU key to return to previous menu.

FM Transmitter Setup via Remote

- Press TFT button.
- Press ▲ / ▼ buttons to scroll to SOUND CONTROL menu.
- Press TFT button to make selection.
- Press ▲ / ▼ buttons to scroll to FM menu.
- Press TFT button to make selection.
- Press ▲ / ▼ buttons to scroll to FM frequency menu.
- Press TFT button to make selection.
- Press ▲ / ▼ buttons to select the desired FM frequency.
- Press the TFT button to return to the previous menu.

Game Mode

- Insert the game disc into the disc drive and wait for it to load.
- Once main menu is displayed, use the ▲ / ▼ / ◀ / ▶ keys on the remote control to navigate through games. Press ENTER on the remote.
- If using remote control to play game, use the ▲ / ▼ / ◀ / ▶ on the remote to control game play. Use the ENTER key to confirm function of item in game.
- Use the RETURN key to exit game.

Installation Guide

Install Instructions (all units)

- To prevent short circuits, remove key from the ignition and disconnect the RED (+12V) cable from battery terminal.
 1. Disconnect the original dome light.
 2. Detach metal mounting plate from Rockville unit (see fig.1).
 3. Attach the metal mounting plate to the roof (see fig.2) using self tapping screws (not provided). Make sure screws attach to interior roof liner.
 4. Connect ground wire harness in the following order:
 - Ground wire (black)
 - ACC wire (red)
 5. Attach the unit to the metal mounting plate using the screws removed in step 2.
- Connection may vary depending on vehicle make and model. Rockville recommends that the installation of this product be performed by an MECP-Certified professional installer.

Fig.1

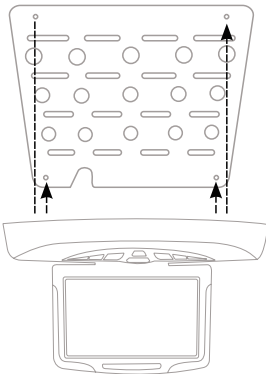

Fig.2

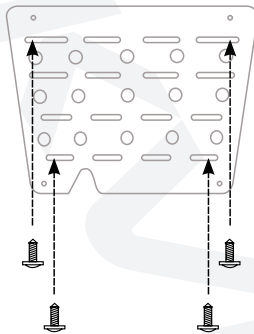
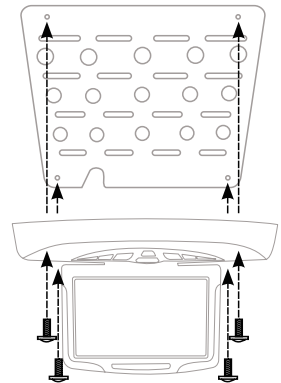

Fig.3



WARNING:

- Be careful not to screw and puncture the exterior roof.
- Use only the screws supplied.

Install Precautions

- This unit should be installed by a qualified technician or service personnel.
- This product is designed to operate with a 12V DC, grounded battery system.
- Use proper insulation and fastening materials to prevent electrical short-circuiting.
- Do not connect the red wire of this product directly to the battery terminal. Remember to connect the red wire of this product to the ACC of the ignition key switch. Failure to do so may result in draining of the battery charge prematurely.
- Do not install this product at a position that may cause injuries to the passenger(s) during an accident.
- Due to different car specifications, please ensure that the display monitor is suitably located.
- Do not install this product at a declining angle exceeding 30°.

Wiring

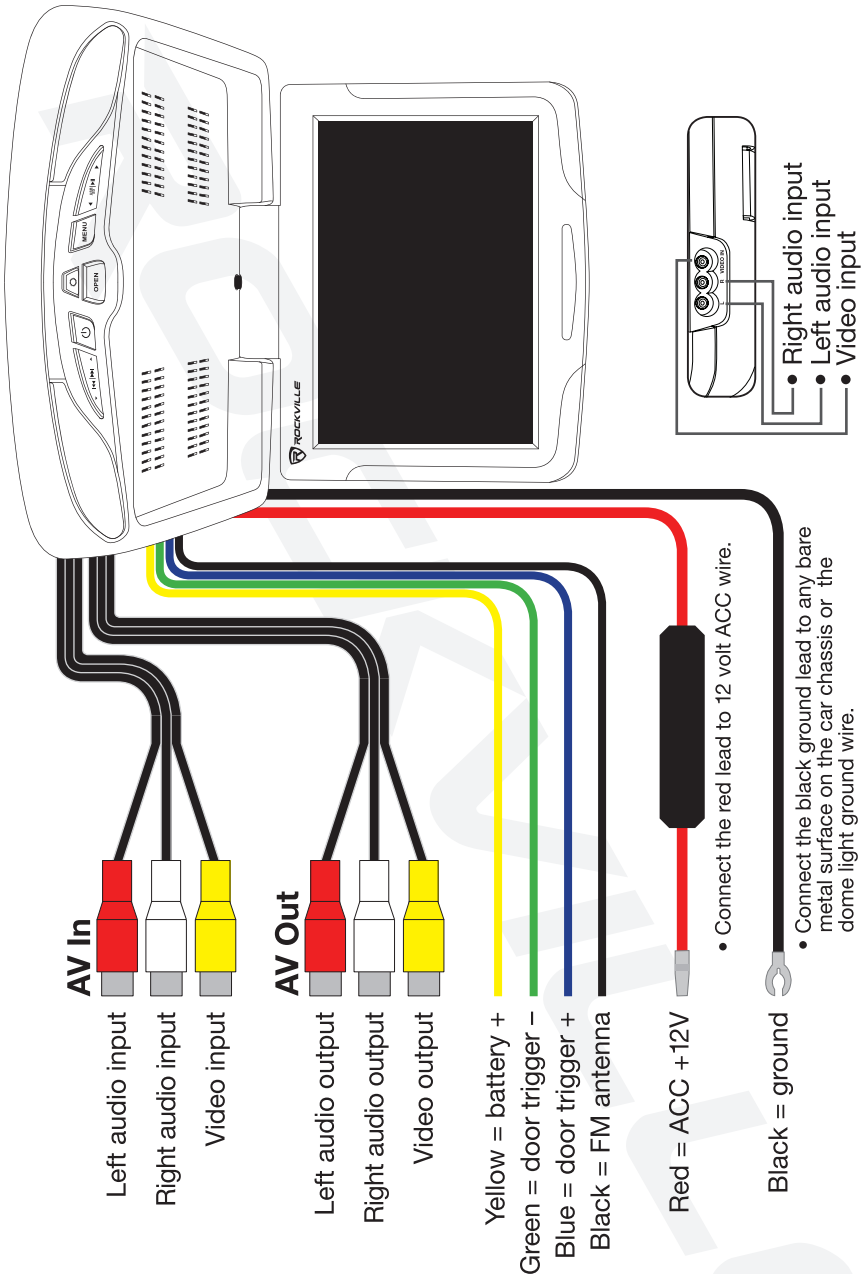

Tip: **AV In** - Use these to connect an external media device such as a camera, game console, etc.

Tip: **AV Out** - Use these to project the display onto external screens such as the headrest monitor.

רשתות
Rockwell

Troubleshooting

No display	Check for loose or disconnected cables. Check input mode settings on the on-screen menu. Check ground cable. Make sure the area it is attached to has no rust or corrosion and is clean. Make sure ground connection is very tight and secure.
No sound/distorted sound	Check for loose or disconnected cables. Try using different RCA cables. Check audio output menu settings.
No power	Check for loose or disconnected cables (power and ground). Check for blown fuses. Make sure to replace fuse with one of the same type.
Poor quality playback	Check the disc for scratches. Clean the disc if needed.
Disc Error is displayed on screen	Turn the unit off and then back on. Check that the disc has been inserted properly: label side up. Check that the disc is in the proper format. Check region settings (PAL/NTSC).
USB/SD files unreadable	Check USB thumb drive/SD card for damage. Check that media files are in the proper format. Media files may be corrupted.
Remote control does not work	Check for any obstructions between the remote and the remote sensor on the unit. Check the remote battery. Bring the remote closer to the unit. Make sure you've removed the plastic tab from the battery compartment.

ROCKWELL
מכונות

ROCKWELL

Visit us at:

RockvilleAudio.com

Due to constant improvements, these specifications are subject to
change without notice.

Copyright 2017